

DIGITAL THERMOSTAT **PT712-EI** FOR FLOOR HEATING

- including external sensor
- backup in case of voltage failure > 100 hours
- direct installation on junction box
- well-arranged backlit display
- VENUS switch design



DESCRIPTION

PT712-EI is a digital thermostat with a room and floor sensor, specially designed for electric floor heating control. The internal-external sensor combination enables the regulation of:

- 1) **floor temperature** (external sensor)- suitable, for instance, for bathrooms where a warm floor is desirable, irrespective of the room temperature;
- 2) **room temperature** (internal sensor)- when comfortable room temperature is required;
- 3) **combined** (both sensors) - the internal sensor scans the room temperature, while the external one monitors the maximum floor temperature; comfortable room temperature is required, however, with simultaneous monitoring of the floor temperat (suitable for wooden and laminated floors).

Another advantage is simple installation in the KU/KP68 junction boxes by means of the PLUG-IN system, as well as the possibility of setting 2 weekly programs with 6 temperature changes per day.

INSTALLATION AND LOCATION

Install the thermostat in a suitable place (minimum height of 1.2-1.5 m above the floor) where its operation will not be affected by direct hot/cold air flow, sunshine or other disturbing influences. Do not mount the thermostat on an exterior wall either. In rooms with increased humidity (bathroom, kitchen), observe valid standards and install the thermostat as far from the bathtub, shower, basin or sink as possible.

The external floor sensor (type CT04-10k, CYXY 2 x 0.5 mm, 10 kΩ, lenght 3 m, PVC plastic case) must be located in a flexible plastic tube embedded in the floor, as near to the surface as possible. The tube must be sealed and protected against in-leak of building materials so that the floor sensor can be replaced easily, if need be. It must not run parallel with power conductors! It can be extended to a maximum length of 30 metres. The installation can only be done by a properly qualified person! Disconnect power supply before installation!

- 1) Switch off the main circuit breaker.
- 2) Check that the junction box is placed parallel with the wall.
- 3) Separate the power part of the thermostat from its microprocessor (main) part; see Fig. 1.
- 4) Pull the connecting terminals out of the thermostat rear part, see Fig. 2.
- 5) Connect conductors to the terminals acc. to the wiring diagram below, see Fig. 3.
- 6) Insert the terminals into the thermostat terminals and fasten the power part to the junction box, see Fig. 4 and 5.
- 7) Insert the main part connector into the power part and push it; the metal springs must fit in the given holes, see Fig. 6 and 7.
- 8) Switch on the main circuit breaker; the thermostat is ready for operation. LCD backlight becomes active only after charging the backup battery (up to 24 hours).
- 9) Set the constant 4 (page 6) according to the load, this could cause an inaccurate display of the current temperature.

Note: We recommend you test correct connection after installation, see the TEST function (page 7).

Wiring diagram:

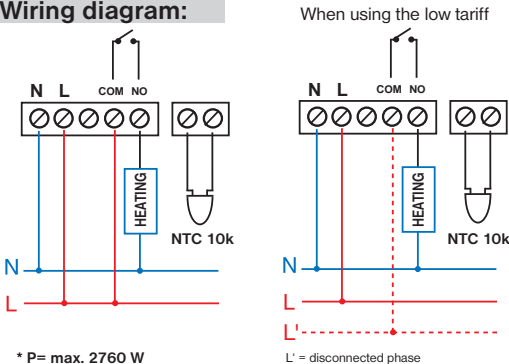
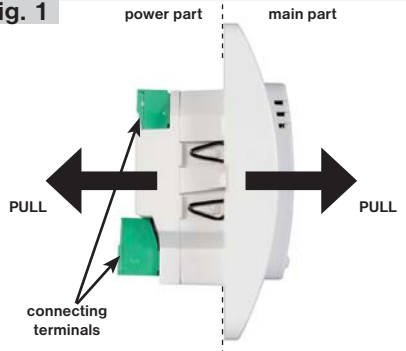
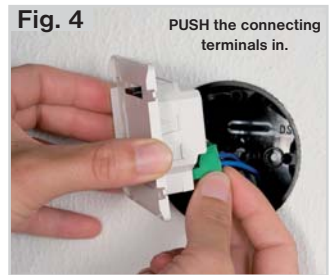
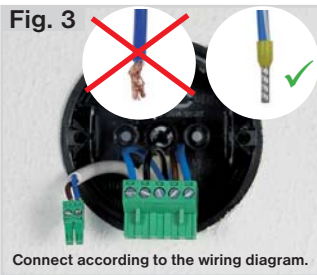
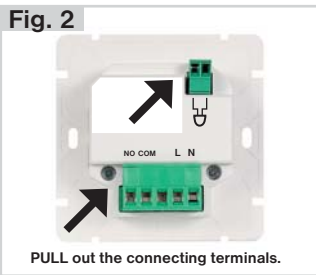
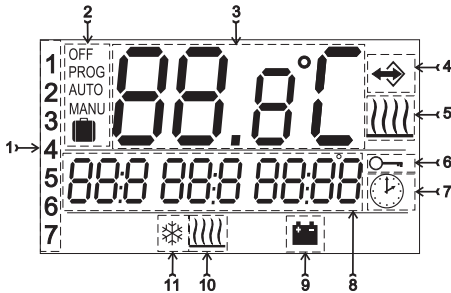

Fig. 1





DESCRIPTION OF LCD AND CONTROL BUTTONS



- 1, Current date (in the Prog mode, selection of number of days for programming)
- 2, Operating modes: OFF/PROG/AUTO/MANU/case=HOLIDAY
- 3, Current room temperature
- 4, Indication of room temp. measurement by the exter. sensor.
- 5, Heating on indication
- 6, Button lock indication
- 7, CLOC mode indication (current date and time setting)
- 8, Required temperature and current time display / listing of operating modes (this line is explained in detail with every mode)
- 9, Battery supply indication (in case of 230V/50Hz voltage failure, it is functional only after 1 day of operation, when the backup battery is charged!)
- 10, Indication of setting the external sensor as the floor one
- 11, Anti-freeze temperature of 3 °C

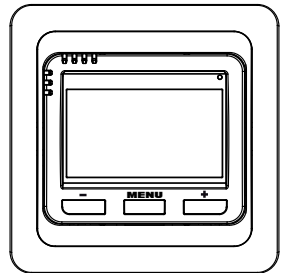

MENU button:

short press = opens the main menu and confirmation (ENTER)

long press (approx. 3 sec.) = back from the main menu

+ / - button:

basic mode = opens info

main menu = browse and set current values

*simultaneous press of the **MENU** and **-***

buttons (in basic mode) = key lock

*simultaneous press of the **MENU** and **+***

buttons (in basic mode) = key unlock

*simultaneous press of the **MENU** and **+ / -***

buttons (in main menu) = return to basic mode

Note: The LCD backlight is activated by pressing any button!

OPERATING MODES

By pressing any button, you activate the display backlight (if the backlight is not working, batteries are not charged and it is necessary to recharge the thermostat about 1 days). Next, pressing the **MENU** button briefly, you enter the main menu, in which you can choose the operating modes.

AUTO

The thermostat works according to the preset weekly program. Press the **MENU** button and choose the AUTO mode with the **+** / **-** buttons. Press **MENU** to confirm.

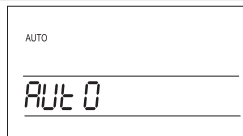

MANU (default setting of 21°C)

The thermostat works according to the preset temperature, which remains constant until the next manual change.

Press the **MENU** button and choose the MANU mode with the **+** / **-** buttons. Press **MENU** to confirm.

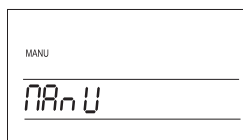

OFF

The thermostat is switched off until the next manual change. Press the **MENU** button and choose the OFF mode with the **+** / **-** buttons. Press **MENU** to confirm.

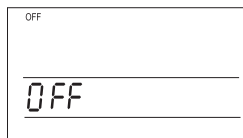

HOLIDAY

The thermostat maintains the preset temperature until the given date and time. When the preset period expires, it returns to the AUTO or MANU mode automatically.

Press the **MENU** button and choose the AUTO or MANU mode with the **+** / **-** buttons. Press **MENU** to confirm.

Press the **MENU** button again and choose the  mode with the **+** / **-** buttons. Press **MENU** to confirm.

The temperature value flashes on the LCD. Set the desired temperature with the **+** / **-** buttons and press **MENU** to confirm it; next, set the hour, minute, day, month and year when your holiday ends; confirm each setting by pressing **MENU**.

After setting, the device automatically switches to the HOLIDAY mode within 1 minute! The holiday end date appears on the display!

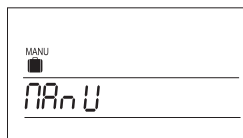
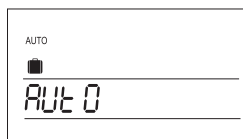

CLOC

Setting the current date and time.

Press the **MENU** button and choose the CLOC mode with the **+** / **-** buttons. Press **MENU** to confirm.

The current hour value flashes on the LCD. Set the current hour and confirm it by pressing **MENU** then, set the minutes and seconds; next, the current date appears; again, set the current day, month and year with the **+** / **-** buttons. Confirm each setting by pressing **MENU**.

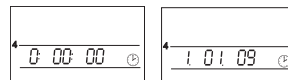
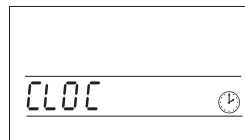

PROG

Setting of weekly programs (2 weekly programs are available, each with 6 changes per day).

Press the **MENU** button and choose the PROG mode with the **+** / **-** buttons. Press **MENU** to confirm.

P1 (the first weekly program) flashes on the LCD; press **MENU** to confirm it; The programmed day number flashes on the LCD, choose one of the options with the **+** / **-** buttons (you can program "day after day", or Mon-Fri, Sat-Sun or Mon-Sun). Press **MENU** to confirm your choice. The display shows **U1** for setting the first temperature change; set the temperature with the **+** / **-** buttons and confirm with the **MENU** button. Set the switching time with the **+** / **-** buttons and confirm with the **MENU** button again.

The display shows **U2** for setting the second temperature change. Follow the procedure for the first temperature change. In this way, you can set up to 6 temperature changes per day. To return to the basic mode, press the **MENU** and **+** / **-** buttons simultaneously.

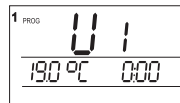
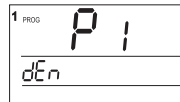
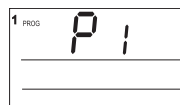
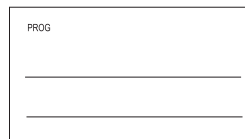

CONST

Setting of the regulation parameters.

Press the **MENU** button and choose the CONST mode with the **+** / **-** buttons. Press **MENU** to confirm it. The first parameter appears on the LCD.

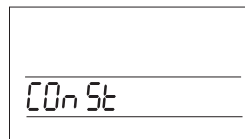

1 HYSTERESIS

The hysteresis can be set from 0.1 to 5 °C. If, for example, the hysteresis is 1 °C and the required temperature is 20 °C, the thermostat switches off at 20 °C and switches on again at 19 °C. Set the pertinent value with the **+** / **-** buttons and press **MENU** to confirm.



2 MINIMUM SWITCH-ON TIME IN HYSTERESIS

Here, you can set the minimum switch-on time of the heating device in hysteresis in minutes. It can be set within the range 1 to 5 minutes. Set the pertinent value with the **+** / **-** buttons and press **MENU** to confirm.

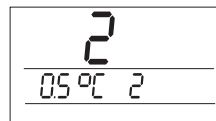

3 EXTERNAL SENSOR SELECTION

Make your choice with the **+** / **-** buttons according to the application type and press **MENU** to confirm.

--- The external sensor, if connected, measures the temperature at the point of location (*suitable, for instance, for bathrooms, where you wish to have a warm floor irrespective of the room temperature*);

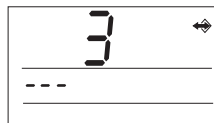

This use of the sensor is indicated by the  sign on the LCD.

15...99,5°C The external sensor, if connected, monitors the floor temperature; the maximum permissible temperature is set for the floor heating (*you regulate with the room temperature, monitoring the floor temperature at the same time*).



The floor (monitoring) sensor is indicated by the  sign on the LCD.

If the preset limit temperature is exceeded, the thermostat is switched off irrespective of the room temperature, and the STOP message appears on the LCD. Once the external sensor temperature drops by 0.5 °C, the heating device is switched on again.

If the sensor is not connected or it is defective, the **C2.Err** error message appears on the LCD.

After connecting the external sensor, it is NECESSARY to RESET the device (see parameter 5)!

4 SELECTION THE POWER OF CONNECTED DEVICE

Set the input of the connected device in watts.

Can be selected in the range from **0 to 2700 W** in steps of 100 W, maximum power is 2760 W. Choosing this constant is achieved more accurate regulation. For a given power starts automatic calibration of the thermostat.

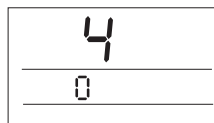

Set the value by **+** / **-** buttons and press the **MENU**.

Use the **option 0** for : boiler, thermoelectric valve, contactor, etc. (for input power less than 100 W).

5 FIRMWARE VERSION / DEFAULT SETTING RECOVERY

Information on the firmware version. If you keep pressing the **-** button (approx. 3 sec), the RESET message appears briefly on the LCD, and the thermostat recovers the default setting!

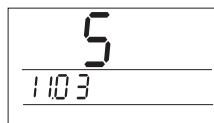

You can exit the CONST mode at any time by simultaneously pressing the **MENU** and **+** / **-** buttons (return to the basic mode).

OTHER FUNCTIONS

INFO

By pressing the **+** / **-** buttons in the basic mode, you can view the following information:

REQUIRED TEMPERATURE

In the basic mode, press the **+** / **-** buttons. The LCD shows the required temperature value for the current operating mode (it can be changed with the **+** / **-** buttons; in the AUTO mode, the change is short-term – until the next change in the program; in the MANU mode, the change is permanent).
With another press of the **MENU** button, you can switch to:

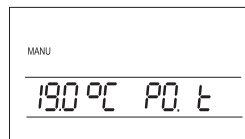

SELECTED PROGRAM NUMBER - in the AUTO mode only

This is used for quick change of the program selected in the AUTO mode. If both P1 and P2 programs are preset, they can be changed, after a week for example, with the **+** / **-** buttons.

With another press of the **MENU** button, you can switch to:

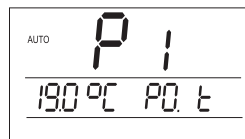

OPERATING HOURS

The LCD shows the operating hour value of the heating device. You can clear it by pressing the **-** button.

With another press of the **MENU** button, you can switch to:

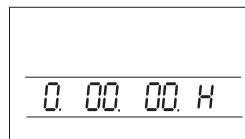

TEST

The LCD shows the **TEST** message, which can be switched to the LCD test on/off with the **+** / **-** buttons (the output relay will be switched on/off several times).

We recommend using this function for the first use of the thermostat to check its correct connection!

With another press of the **MENU** button, you can view prior information if the external sensor is connected as the floor (monitoring) one:

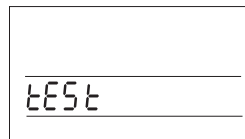

CURRENT TEMPERATURE OF THE FLOOR SENSOR

The LCD shows the current temperature value of the floor sensor.



To return to the basic mode, keep pressing the **MENU** button (for approx. 3 sec)!

LOCK

In the basic mode, simultaneously press the **MENU** and **-** buttons, the buttons will lock (the key sign on the LCD). Unlocking can be done by simultaneously pressing the **MENU** and **+** buttons.

DIGITAL THERMOSTAT

PT712-EI

Used for the control of electric floor heating (heating cables, mats, foils). It enables regulation according to the room temperature with possible floor temperature monitoring. Using the thermostat, you can reduce heating costs and, at the same time, achieve thermal comfort at the given time.

Properties:

- ▶ 2 weekly programs with 6 temperature changes per day
- ▶ backlit display
- ▶ HYSTERESIS setting option
- ▶ heating source minimum switch-on time setting
- ▶ operating modes:
AUTO/MANU/OFF/HOLIDAY
- ▶ maximum floor temperature setting limit value setting
- ▶ quick change of the required temperature
- ▶ operating hours information
- ▶ child lock – locking of keys
- ▶ backup in case of voltage failure for more than 100 hours
- ▶ simple installation (PLUG-IN system)
- ▶ elegant design of the VENUS switch series

The PLUG-IN system = quick and easy installation. The thermostat is divided into the power part and the main microprocessor part, which can be connected by simple insertion of the interconnecting terminals. The input conductors (or external sensor) are connected to the power part terminals and fastened to the junction box; then you can simply finish the installation by inserting the main part onto the power part.

External sensor:

included in the package
type CT04-10K,
CYXY 2 x 0.5 mm,
10 k Ω , length 3 m,
PVC plastic case



Dimensions:

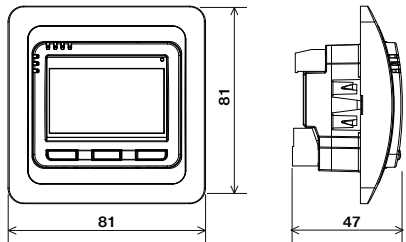

Another advantage:

The thermostat can be located in the multiple frame of the VENUS design.



WARRANTY CERTIFICATE

(a 2-year warranty is granted for the product)

| | |
|-----------------|---------------|
| Product number: | Date of sale: |
| Checked by: | Shop stamp: |

Technical parameters

| | |
|----------------------------|-----------------------------------|
| Power supply | 230 V/ 50 Hz |
| Number of adjustable temp. | 6 different temp. per every day |
| Hysteresis | 0.1 to 5°C |
| Minimum program time | 10 minutes |
| Adjustable temp. range | +3°C to 99.5°C |
| Temperature setting | by 0.5°C |
| Minimum indication step | 0.1°C |
| Measurement accuracy | ± 0,5°C |
| Backup battery | more than 100 hours |
| Protection class | IP20 |
| Protection rate | II |
| Output | max.12A (potential-free contacts) |
| Working temperature | 0°C to +40°C |



In case of warranty or post-warranty service, send the product to the manufacturer's address.



ELEKTROBOCK CZ s.r.o.
Blanenská 1763
Kuřim 664 34
Tel.: +420 541 230 216

www.elbock.cz